

PRO Series

Specification

D8120

24V-8mm-9.6W



【General description】

- Double leds per cut for 24V, easily for customized application
- Self-encapsulated design offers 5 optional 1900-6000K white lights
- High quality PFC, high thermal 3M adhesive
- With life span over 60000H
- Ta: -25~40°C; Tc: 75°C (max)

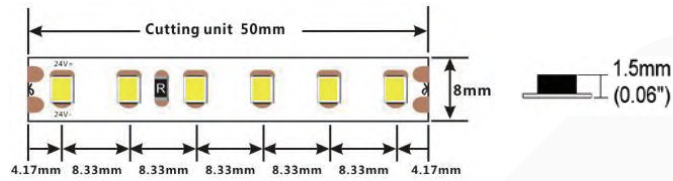

【Dimension】

- | | |
|------------------------------------|--|
| Input voltage: DC24V | Max.length: 5000mm(16.4') |
| CRI: >80/90/95 | Cutting unit: 6leds/50mm(1.98") |
| Max.power: 9.6W(1m) | LED pitch: 8.33mm(0.33") |
| Power range: 7.5 ~9.6W(1m) | Min. bend diameter: Φ 60mm(2.36") |
| Rated current: 0.35A(1m) /1.4A(5m) | Mounting: 3M tape |
| Typical Power: 8.4W(1m) /33.6W(5m) | Copper foil: 3oz |
| tape IP: IP20/IP65/IP67/IP68 | |
| On-off times: 10000 (test times) | |
| Warranty: 5years | |

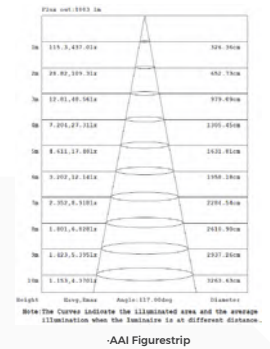
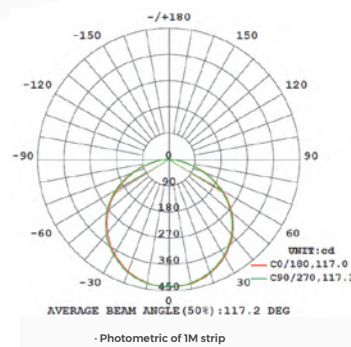

【Photo-electric Parameters】

CRI	Color	CCT	Lumen(lm)	lm/W	Energy efficiency class
Ra>90	SW	2700K	745	89	G
Ra>90	WW	3000K	790	94	G
Ra>90	PW	3500K	795	95	G
Ra>90	NW	4000K	820	98	G
Ra>90	DW	5000K	820	98	G
Ra>90	W	6000K	790	94	G
0	G	525-530nm	/	/	/
0	B	465-470nm	/	/	/

- 1.The tolerance of output data can be vary up to 15%.
- 2.the output data tested according to IES TM-30-15.
- 3.the output data is based on IP20/lmmerter, data of 5m in only for reference.
- 4.IP protection process leads changes to size, CCT and luminous flux.



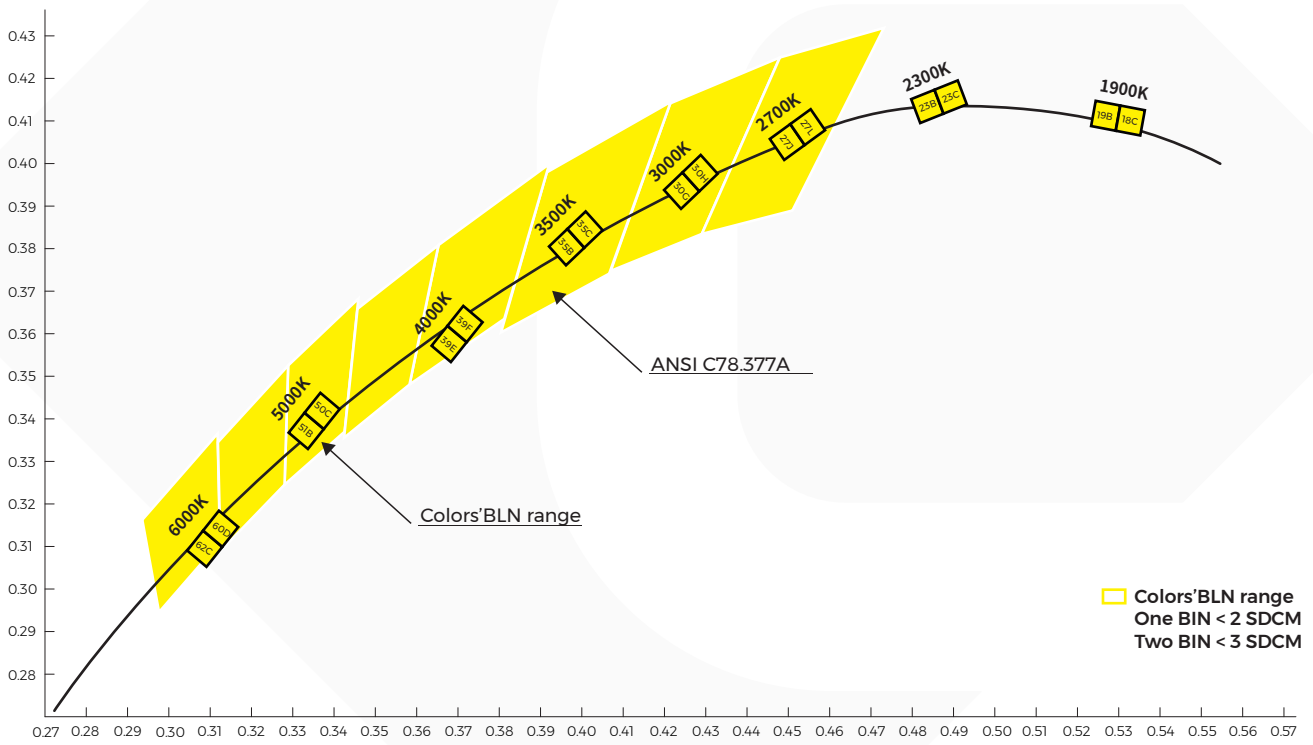

[BIN]

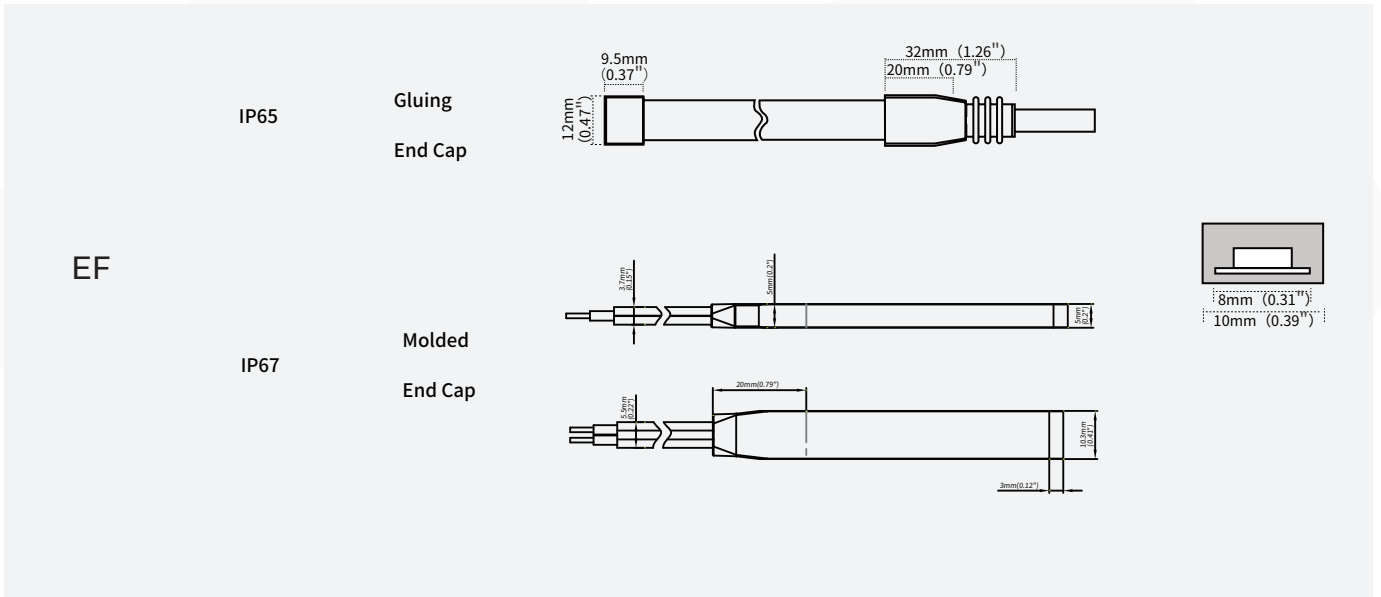
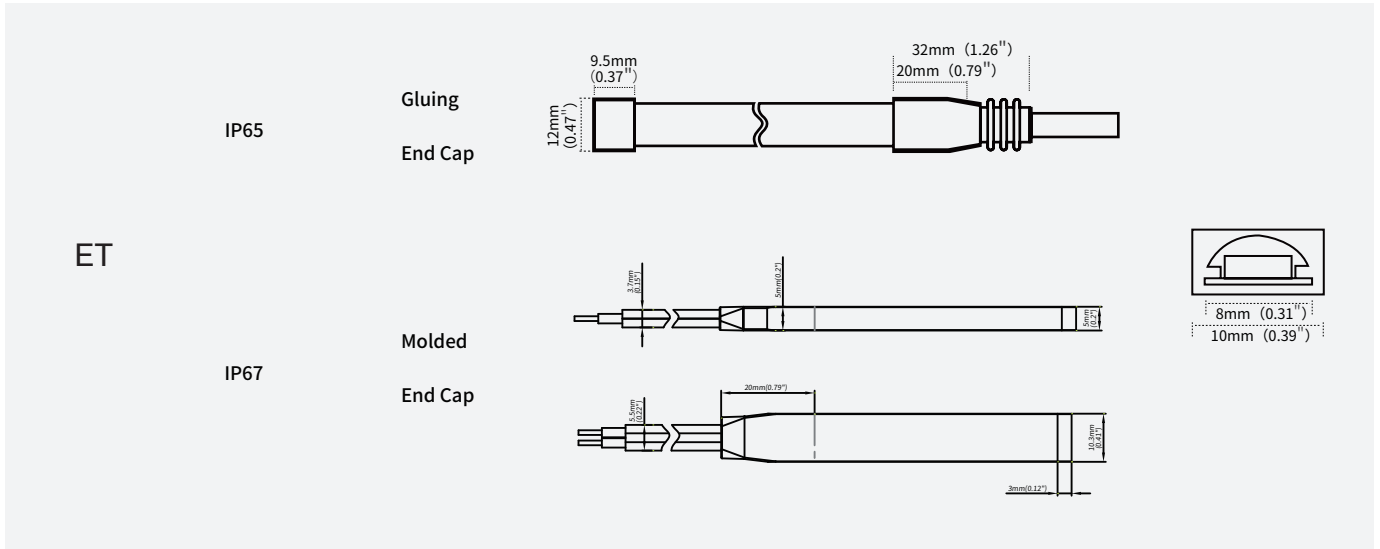









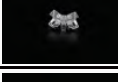

【 IP process structure and size 】

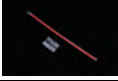

【IP Process Parameters】

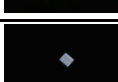
IP Process	Picture	Picture description	Size	optional CCT/color for finished product	lumen output rate
NO		No proof	8mm*1.5mm	1900K/2300K/2700K/3000K/3500K/4000K /5000K/6000K/G/B	100%
NA		Nano-proof	8mm*1.6mm	1900K/2300K/2700K/3000K/3500K/4000K /5000K/6000K/G/B	98%
ET		Extrusion tube	10mm*4.8mm	1900K/2300K/2700K/3000K/3500K/4000K /5000K/6000K/G/B	88%
EF		Extrusion filling	10mm*5mm	2300K/2900K/3400K/3850K/5800K/8750K /15000K/G/B	86%

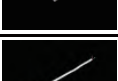
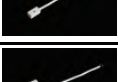
【Accessories Information】

Name	Picture	Code	description
Connector for wire and FPC		94-42-620800001	8mm width, 2PIN connector of wire and FPC, suitable for white color strip, NO/NA, 2PIN wire 18- 22AWG
Connector for FPC and FPC		94-42-620800002	8mm width, 2PIN connector of FPC and FPC, suitable for white color strip, NO/NA
Slim connector		81-01-000000-000064	Suitable for 8mm board width, IP20, 2PIN board-to-board solderless terminal
Slim connector		81-01-000000-000066	Suitable for 8mm board width, IP20, 2PIN wire- to-board solderless terminal
Fixed Clip		94-02-00-0002	Silicone clip, screw: PA 3*8mm, suitable for 8mm FPC, EF/ET strip
Gas phase rubber plug		18-01-08-0025	Translucent gas phase adhesive plug, suitable for 8mm wide silicone extrusion eg lamp with
Gas phase gel plugging		18-01-08-0026	Translucent gas phase adhesive plug, suitable for 8mm wide silicone extrusion eg lamp with end plug
Silicone Plug Kit		94-02-00-0044	Silicone plug kit, suitable for 8mm board width, ET/EF series silicone extrusion light strip
Silicone stopper kit		94-02-00-0045	Silicone tail plug kit, suitable for 8mm board width, ET/EF series silicone extrusion light strip
Mounting groove		94-02-00-0024	8mm width, 2PIN connector of wire and FPC, Transparent PVC mounting groove, suitable for 8mm FPC, silicone extruded EF/ET strip
ET solderless plug		94-03-00-0027	Monochromatic light strip, 8mm board width, ET protection technology
ET press-fit terminals		94-03-00-0028	Monochromatic light strip, 8mm board width, ET protection technology
ET press-fit terminal kit		94-03-00-0029	Monochromatic light strip, 8mm board width, ET protection technology
Stopper glue		94-16-03010001	Silicone gel, suitable for ET/EF/EC/ERG waterproof LED strip

【Packing】

Colors brand package



General customized package

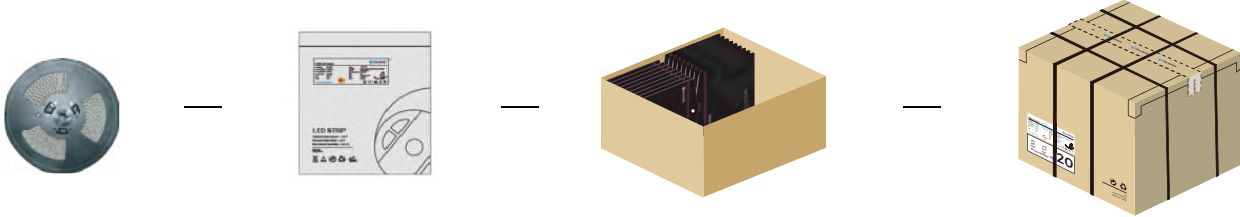

IP Process	Product size(mm)	Product quantity (m/reel)	Product quantity (m/case)	Product net weight(kg)	Net weight per box(kg)	Gross weight(kg)	Package size (cm)
NO	5000*8*1.5	5	300	0.115	6.9	7.935	41*41*26
NA	5000*8*1.6	5	300	0.118	7.04	8.142	41*41*26
ET	5000*10*4.8	5	200	0.44	17.6	20.24	41*41*26
EF	5000*10*5	5	200	0.486	19.44	22.36	41*41*26

Remark: data with 10% tolerance

· Engineering packaging of ET(IP67)/EF(IP67)

(free-soldering end caps with 40 cover per box could be ordered separately if needed)



· Engineering packaging of NO(IP20)/NA(IP65).

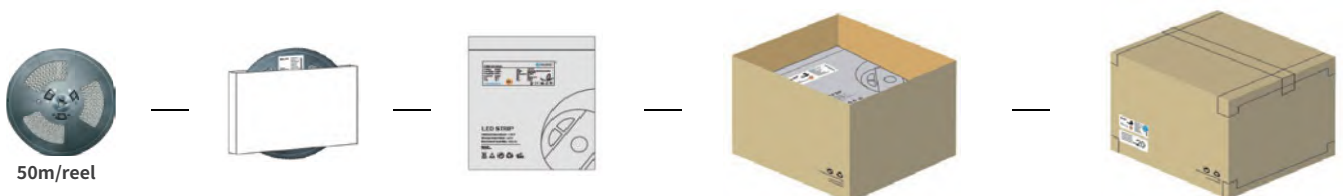

IP Process	Product size(mm)	Product quantity (m/reel)	Product quantity (m/case)	Product net weight(kg)	Net weight per box(kg)	Gross weight(kg)	Package size (cm)
NO	5000*8*1.5	50	650	1.15	14.95	17.193	41*41*26
NA	5000*8*1.5	50	650	1.18	15.34	17.641	41*41*26
ET	5000*10*4.8	50	100	4.48	8.96	10.304	25.5*25.5*26
EF	5000*10 *5.0	50	100	4.95	9.9	11.385	25.5*25.5*26

Remark data with 10% tolerance

【Precautions】

- Please drive the led strip with 24VDC isolated power, and the ripple of the constant voltage source should be less than 5%.
- Please do not bend the strip into an arc with a diameter less than 60mm to ensure the longevity and reliability.
- Do not fold it in case any damage of LED beads.
- Do not pull the power wire hard to ensure the longevity.Any Crash may damage the LED light is prohibited.
- Please make sure the wire is connected to the anode and cathode correctly. The power output should be consistent with the voltage of the strip to avoid damage.
- LED lights should be stored in dry, sealed environment. Please only unpack it before usage. Ambient temperature: -25℃~40℃.Storage temperature: 0℃~60℃.Please use the strips without waterproof within indoor environment with humidity less than 70%.
- Please be careful during operation. Do not touch the AC power supply in case of electric shock.
- Please leave at least 20% power for the power supply during using to ensure there is enough power supply to drive the product.
- Do not use any acid or alkaline adhesives to fix the product (e.g.: glass cement).
- Do not scratch the product when IP processof the product is NA. Ultraviolet rays will damage the nano-layers on the product and seriously affect the life of the product.